

MODEL: SP12C7

(Portable 4 gas detector)

Operating Manual



Guarantee and Repair

Senko Co., Ltd. guarantees the products of SP series for 24 months from the shipping date and repairs or replaces the defected product during warranty period at no cost. Nevertheless, Senko is not responsible for the following cases and would not repair or replace the product at no cost, such cases as the product has been purchased through the route that Senko does not approve, or as the product has been damaged or deformed mechanically by misuse of the user, or as the product has not been calibrated or replaced the parts according to processes in the operating manual.

In the event that any defect or issue of the product occurred during warranty period, Senko will cover all the expenses except transportation fee. After the period of warranty, the expenses of repair or replacement of the product and transportation will be in principle borne by the user. Senko will not be responsible for any indirect occurrence or accident and/or damage during the use of the product, and the guarantee shall be limited to the replacement of parts and product. The guarantee is applied only to the users who purchased the product at Senko's authorized dealers or agents, and the guaranteed repair is to be performed by the expert engineers of Senko's authorized aftercare center.

Introduction

SP12C7 is 4 Gases Alarm Detector that is required to protect users' safety at dangerous work environments where an explosion accident can occur. The apparatus can indicate simultaneously the concentration of 4 gases (Oxygen, Inflammable Gas, Carbon Monoxide and Hydrogen Sulfide) on a digital LCD monitor, and the methods of operation and calibration are easy and convenient.

This instrument alerts accurately the alarm circumstances to operators and workers for their safety with its functions of loud alarm sound and vibration, when higher gas concentration than normality is detected. Besides, it is available for users to check upon occasion and adjust the value of alarm to the work environment on demand, since it has the function of indicating minimal and maximal concentration of the gases. It is also possible to prevent in advance workers from the danger of exposing for a definite period of time to such toxic gases as Hydrogen Sulfide (H₂S) and Carbon Monoxide (CO) by its function of STEL (Short Term Exposure Limit) and TWA (Time Weighted Average).

Contents of Operating Manual

Product Specification -----	4
Names and Functions of Exterior -----	5
Start of Operation -----	6
Operation Method -----	7
Calibration -----	8
Method of Alarm Set and Display -----	11
Applicable Battery and External Pump -----	15
Battery & Sensor replacement -----	16
Operation Flow Chart -----	17
Notice for User -----	18

Product Specification

MODEL	SP12C7			
Detecting Gas	O ₂	CO	H ₂ S	EX
Detecting Range	0~30%	0~500ppm 0~1,000ppm	0~100ppm 0~200ppm	0~100%LEL
Sensor Type	Galvanic	Electrochemical	Electrochemical	Catalytic
Sampling Method	Diffusion			
Display	Digital LCD			
Audible Alarm	90dB			
Visual Alarm	Red LED & White back light			
Vibrator Alarm	Vibrator			
Power	Alkaline battery 2ea, Rechargeable NI-MH battery pack			
Operating temp. & Humi.	-20°C ~ +50°C, : 15% ~ 90% RH (non-condensing)			
Explosion proof	EEx ia IIC T4			
Case	Clear polycarbonate with thermal-plasticelastc (TPE) overmold.			
Standard Accessories	Belt Clip, Charger			
Option	External pump			
Dimensions	54mm(W) x 135mm(H) x36.5 mm(D)			
Weight	240g			

Specification of External Pump (Optional)

Power	AA size Alkaline battery 1ea
Operating time	More than 5 hours
Operating temp. & Humi.	-20°C ~ + 50°C, 0 to 95% RH
Sampling flowrate	0.5 liter / min
Self Checking	Low flow alarm, Low battery alarm (Red LED)
Dimensions	34mm(W) x 270mm(H) x 47 mm(D)
Weight	200g (with battery)

Names and Functions of Exterior

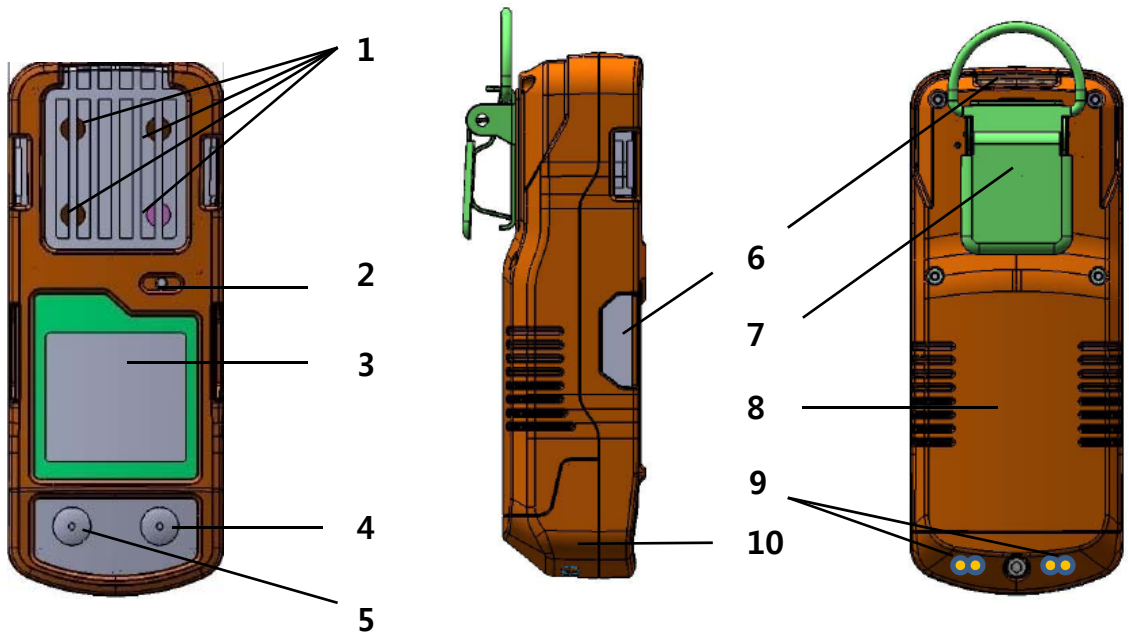

- 1. Gas sensor
- 2. Buzzer
- 3. LCD display
- 4. On/Off Key
- 5. ⇨ Key
- 6. Alarm LED
- 7. Fastening clip
- 8. Type label
- 9. Charging contacts
- 10. Battery pack

LCD display symbols

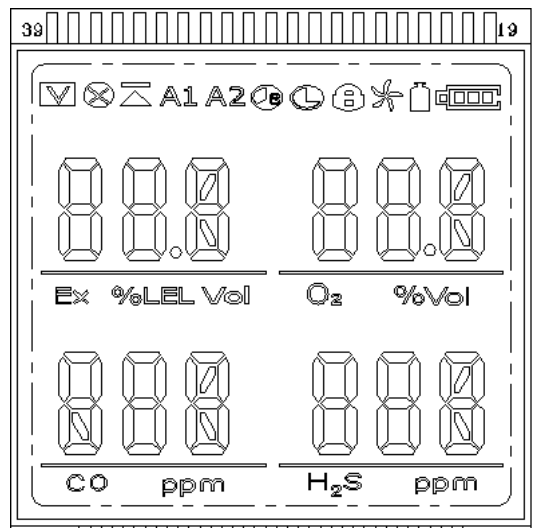

- Test pass
- Fault
- Display peak Value
- A1** First alarm
- A2** Second alarm
- Show TWA
- Show STEL
- Password required
- Fresh air calibration
- Single gas calibration
- Show Battery

Start of Operation

Instrument Power-On



Press Power key for 3 seconds, and power is turned on displaying 3, 2, and 1 in order on the monitor. (Power won't turned on, if pressing the Power key is stopped before 3 seconds)

Afterwards during the instrument is being stabilized, it displays consecutively A1 & A2 set values of LEL Gas, A1 & A2 set values of O₂ Gas, A1 set value of CO Gas, A2 set value of CO Gas, set values of STEL & TWA, A1 set value of H₂S Gas, A2 set value of H₂S Gas, and set values of STEL & TWA on the monitor.

When the instrument is stabilized after the display of the above set values, it converts to Gas Detection Mode displaying the mark **V**. At normal status, the mark **V** disappears after 30 seconds, and the concentration of the gas detected of the moment is indicated. In the event that stabilization of the instrument fails, it would not convert to Gas Detection Mode, blinking the mark **X** with alarm sound. In this case, calibration of the sensor or aftercare of the instrument is required.

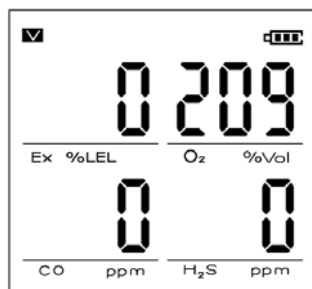

Success

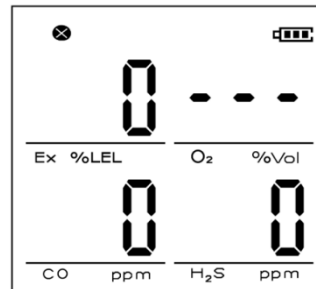

Fail

Instrument Power-Off



Press Arrow key for 3 seconds at the state of pushing Power Key simultaneously, and power is turned off displaying 3, 2, and 1 in order on the monitor with turning on LED Lamp and alarm.

Caution: Appropriate calibration of the instrument is always required prior to the operation at work sites. Make sure if the instrument makes the proper detection response to the pertinent gas and if the region of the gas detection is not blocked with foreign materials that interfere with the gas detection

LCD Back Light



At the state of Gas Detection Mode indicating the concentration of 4 kinds of gases simultaneously, LED Backlight is turned on by the short press on Arrow key, and it is turned off by pressing again once more. It enables the operator to view the measured value even at dark atmosphere. Backlight will be automatically turned off after 10 seconds unless the button works.

Operation Method

Detection Mode

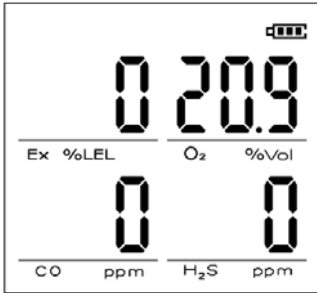

The instrument is converted to Gas Measure Mode as below, when power is turned on. Gas Measure Mode indicates the concentration of gas and the remained capacity of battery on LCD, and it displays the gas concentration of Oxygen by %, Inflammable Gas by %LEL, H₂S and CO Gas by ppm units.

In the event that the concentration of the specific gas changes, it indicates the value of concentration in real-time. If it exceeds A1 or A2 Alarm standard (or STEL / TWA), the measured value and A1 or A2 (icon in case of STEL / TWA) is displayed at one second interval in turn alerting by alarm sound and vibration.

As of A1, the instrument program will be converted to the original condition and starts the operation, when the concentration value of the measured gas returns to the normal state. (LED and LCD Backlight are displayed continuously and the alarm sound stops, if power key is pressed during the alarm sounds. During the alarm sound, the measured value and A1 or A2 are displayed in turn on LCD.) In case of A2, power should be disconnected in order to stop the alarm.

When the concentration value of the measured gas exceeds the maximum measuring range, it is indicated as the maximum value. And LED, alarm sound and vibration applicable to A2 Alarm Standard operate together

Indication of Peak Value and TWA & STEL Value

At Gas Measure Mode, Peak value is displayed (Peak values of all 4 sensors) by pressing Arrow key for 3 seconds, the value of TWA (only for CO and H₂S) is shown by pressing it again, and that of STEL (only for CO and H₂S) is indicated consecutively by pressing it once more.

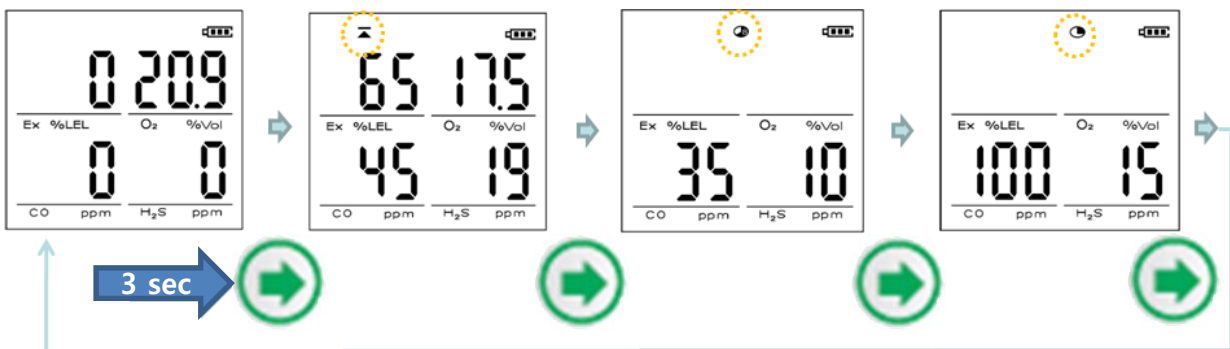

The program returns to Gas Measure Mode by pressing Power key at the state indicating Peak, TWA and STEL. And it reverts automatically to Gas Measure Mode as well without using the button for 30 seconds at the state of Peak, TWA and STEL.

Calibration

Caution: Senko Co., Ltd. performs the initial calibration before the shipment. Incorrectly calibrated value can reduce the accuracy of the product, as the calibrated value is stored in the instrument. Calibration is in general to be performed monthly or quarterly, and can be adjusted according to frequency of the use.

Fresh air Calibration

Press Power key for 5 seconds and input password (refer to the way of password input), and Lock icon will blink. Then press Arrow key to make the icon  blink. When Power key is pressed at the state, it converts to Calibration mode of the standby state.

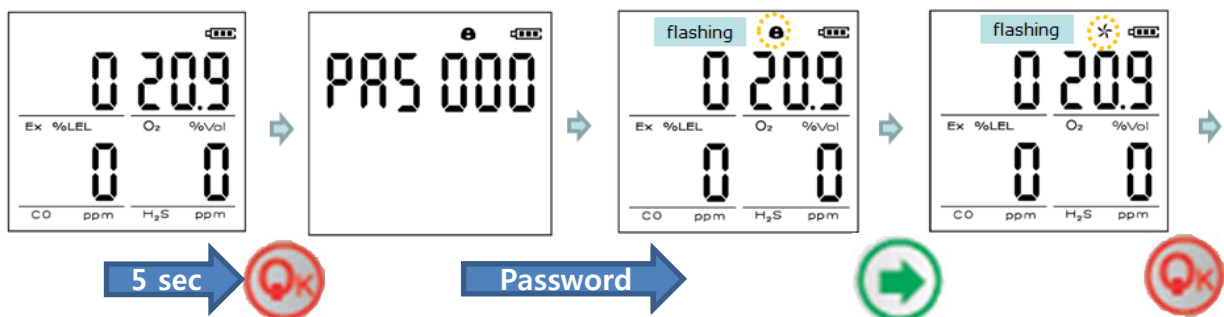

Calibration will be processed, when Power key is pressed after entering to Calibration mode of the standby state. Calibration will be completed by 3 time blinking of 4 sorts of gas concentrations, and the mark OK is displayed.

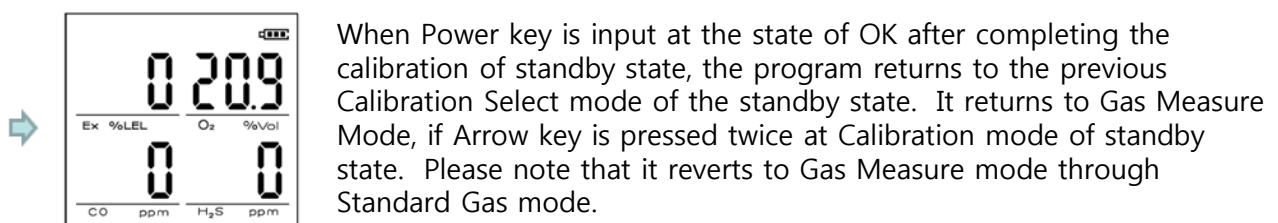
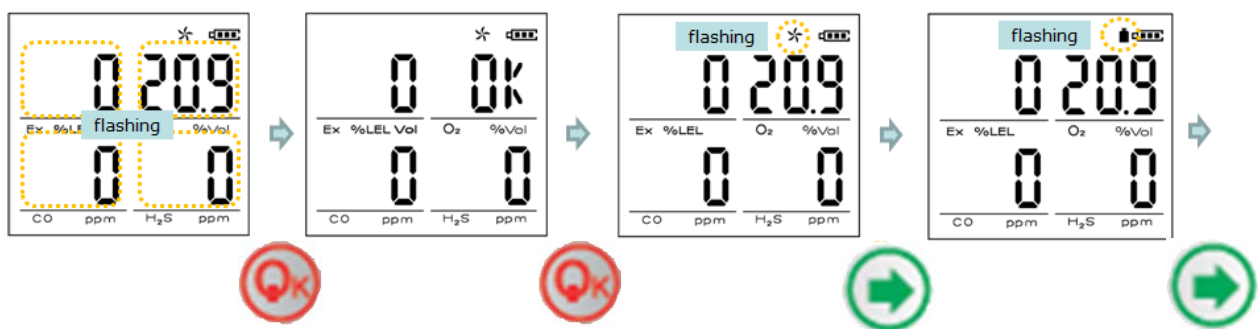

When Power key is input at the state of OK after completing the calibration of standby state, the program returns to the previous Calibration Select mode of the standby state. It returns to Gas Measure Mode, if Arrow key is pressed twice at Calibration mode of standby state. Please note that it reverts to Gas Measure mode through Standard Gas mode.

Caution: Fresh Gas Calibration should be performed at the environment of fresh air without any influence of other gases, since the calibration is performed on the assumption that the concentration of Oxygen is 20.9%, that of Inflammable Gas is 0%LEL, and the concentration of Toxic Gas is 0ppm in the fresh air. Accordingly it is not recommended to perform Fresh Air Calibration at the closed space, and it should be avoided to perform the calibration where gases can be inhaled by operators.

Standard Gas Calibration

Press Power key for 5 seconds and enter the password (the initial password is 000), then Lock icon will blink. And press Arrow key to see ✨ icon blink. The icon 🔒 will blink, when the operator presses again Arrow key once more. Then it enters to Standard Gas Calibration Mode of, as Power key is pressed.

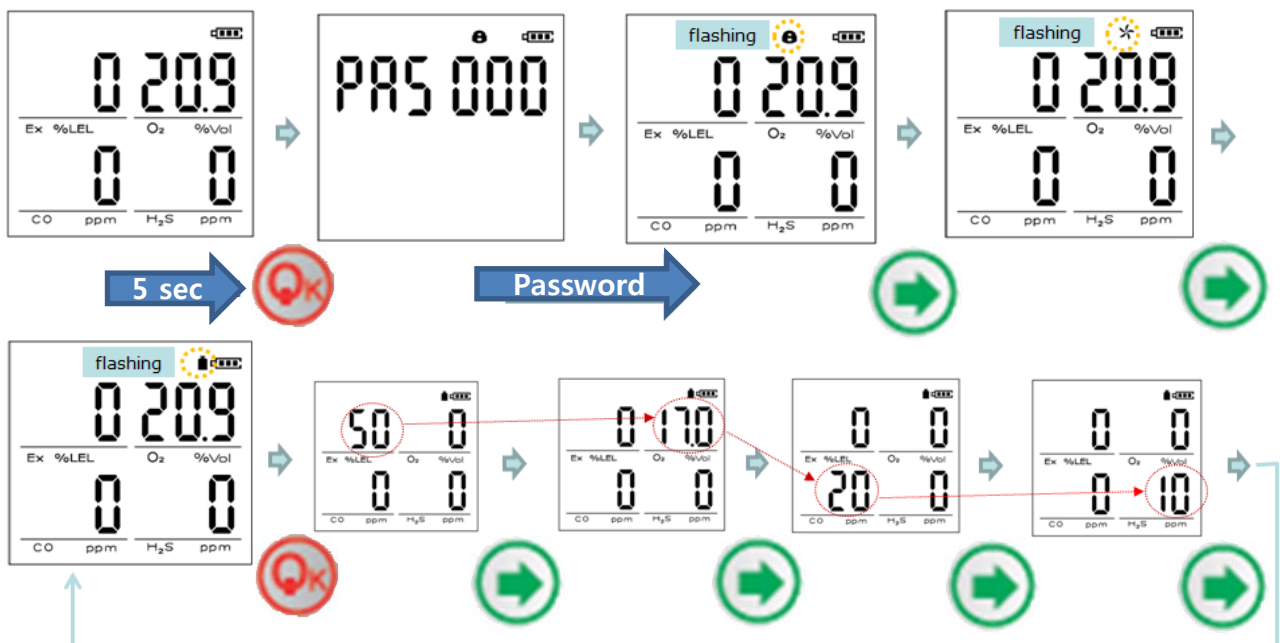

When the program is converted to Standard Gas Calibration Mode, %LEL Standard Gas Concentration that has been initially input is displayed. And it moves to each Calibration Mode respectively, indicating the values of Standard Gas Concentration of O2, CO and H2S that have been input by Arrow key.

Concentration of Calibration Gas set at Instrument

Gas	Combustible	Oxygen	Carbon monoxide	Hydrogen Sulfide
Concentration	20 %LEL	0%	100 ppm	50 ppm

Method of Calibration

The method of Standard Gas is as below. The program enters to %LEL Calibration Mode blinking the numbers, when Power key is pressed at %LEL Standard Gas Calibration Mode. In case that the inflammable gas that conforms to %LEL concentration input initially at the instrument is used, calibration is executed indicating the concentration value connected at the moment by pressing Power key twice. In case that using Standard Gas of different concentration from that of %LEL initially input, proceed with calibration after changing the concentration to that of the required Standard Gas by the same way as the input of password as shown at the diagram below. Then the concentration value of the calibration gas connected at the moment is indicated with the countdown of 60 seconds. If there does not occur any problem of calibration for 60 seconds, the concentration of the calibrated gas is displayed after memorizing the concentration of calibrated gas as the value of sensor. Methods of the calibration for the sensor of CO, O₂ and H₂S are to be proceeded same as the following diagram.

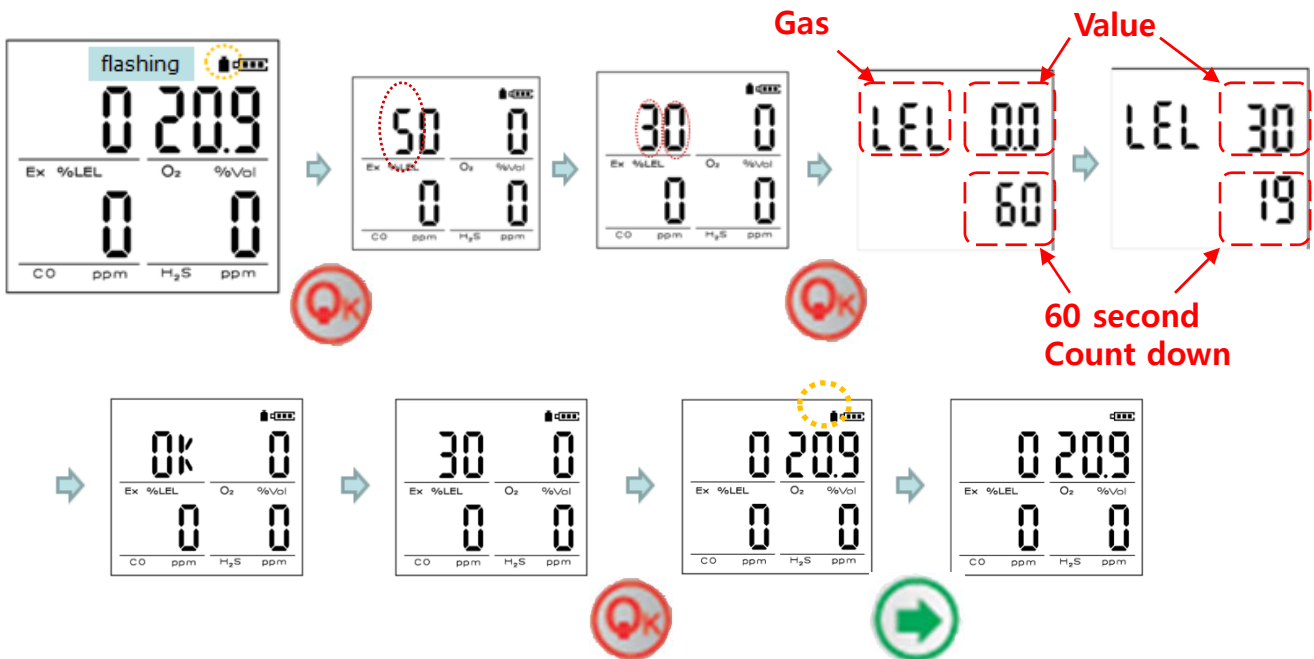

Failure of Calibration

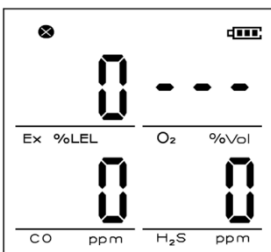



In the event that Gas Calibration fails, the mark --- is displayed at the value of calibration with the icon of Test Failure. If this occurrence repeats, please consult a dealer or aftercare center to replace the sensor.

Method of Alarm Set up and Display

Caution: The value of alarm of the instrument is set according to the alarm standard of each gas that is required by international standard. Therefore alarm value of the relevant gas can be changed under the responsibility and approval of the administrator of the work site where the instrument is used.

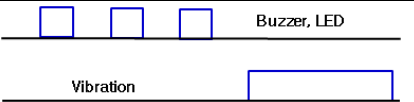
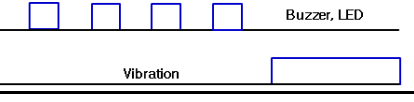
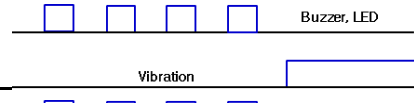
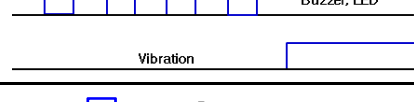
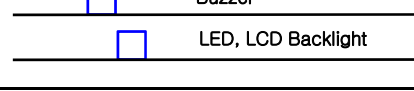
Alarm Display

Alarm	Alarm Standard	LCD Display	Alarm & Vibration Display
A1	In Exceeding Alarm Value Set Primarily	Displaying Icon A1 & Concentration	
A2	In Exceeding Alarm Value Set Secondly	Displaying Icon A2 & Concentration	
TWA	In Exceeding Exposure Concentration for 8 hour	Displaying Icon TWA & Concentration	
STEL	In Exceeding Exposure Concentration for 15 minutes	Displaying Icon STEL & Concentration	
Low	Remained Battery Capacity is small (one bar)	Blinking of	
Test Failure	Failure of Sensor Test Failure of Calibration	Displaying Icon Test Failure	

When A1 alarm occurs, and the operator recognizes it and presses Power key, only the sound and vibration of alarm stop, remaining LED alarm as the operation stale.

When A2 alarm happens, the operator and workers should promptly escape from the work site. The alarm will stop, when power is turned off at the place where the concentration value of gas is normal after moving to a safe region. (If the instrument is operated again at an abnormal environment, the warning of test failure is displayed.)

When STEL / TWA alarm occurs, it is indicated with the value of the measured concentration and alerts alarms of the same sound of alarm and vibration as that of A2 alarm.

When STEL / TWA alarm occurs, the icon can be deleted only by Power Off.

Note: It is available to set the different alarm sound of each gas respectively by requirement of the user. Please consult Senko Co., Ltd. for further detailed information.

Primary battery alarm sounds repeatedly at 5 minute intervals when only a bar of battery icon is remained.

Secondary battery alarm starts right before the end of power, and the power source finishes after 10 seconds from the outbreak of alarm.

In the event of failure of test or calibration, the icon of Test Failure is displayed with the sound of alarm.

Alarm Set Point (TWA, STEL)

Gas	Combustible	Oxygen	Carbon monoxide	Hydrogen Sulfide
A1	20 %LEL	19%	30 ppm	10 ppm
A2	40 %LEL	23%	60 ppm	20 ppm
TWA			30 ppm	10 ppm
STEL			200 ppm	15 ppm

Alarm Set

When Lock icon blinks after entering password, approach to A1 Alarm Value Set Select Mode by pressing Power key. **Note: If Arrow key is pressed during blinking of Lock icon, the program moves to Calibration Select Mode likely Sensor Calibration Mode. Please pay attention to this point.**

A1 icon blinks, when Power key is pressed at Lock Blink Mode. It will be converted to A1 Alarm Mode by pressing Power key, and the blinking icon will be alternated in the sequence of A2, TWL, STEL and Password. If you want to approach to each Alarm Value Set Mode, enter it by pressing Power key. Please use Arrow key in order to escape to Gas Calibration Mode.

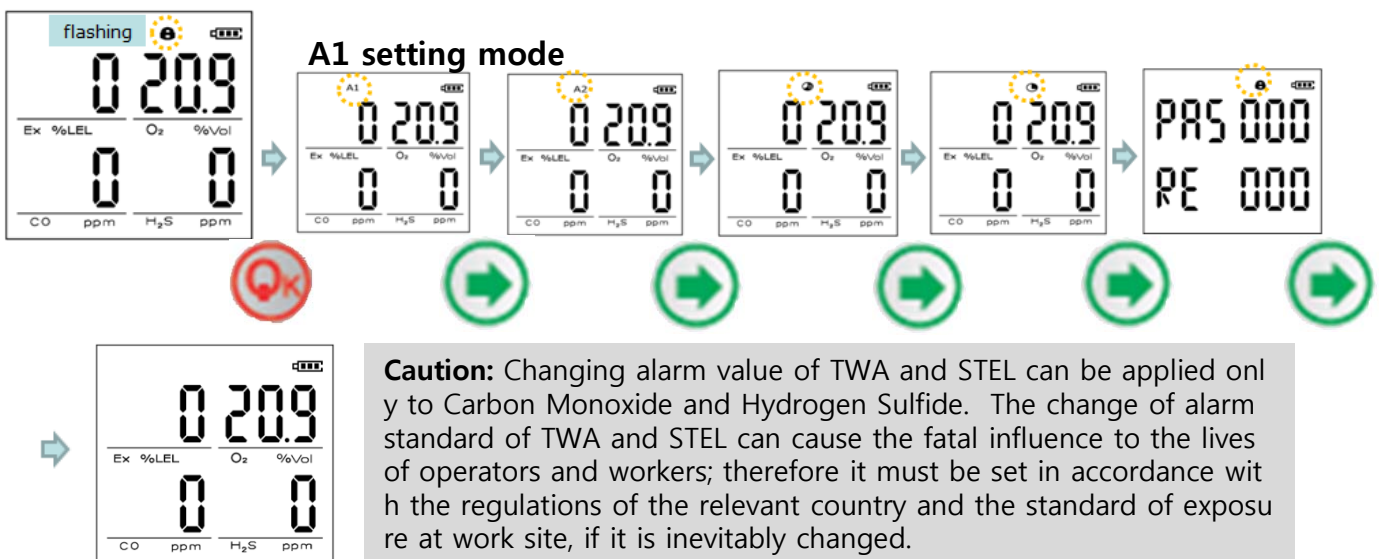

Alarm Set of Each Gas

A1 icon blinks by pressing Power key at Lock Blink Mode. And it is converted to %LEL Alarm Value Set Mode by pressing Power key again.

After moving to %LEL Alarm Value Set Mode, Alarm Value of %LEL, that has been input initially, blinks. And the Alarm Value can be changed by the same method as password input. Changing sequence of Alarm Value is %LEL, %Vol, Oxygen, Carbon Monoxide and Hydrogen Sulfide, and it returns to A1 Set Mode when the change of Alarm Value of each gas is completed.

Note: In case of Inflammable Gas, it is determined by Alarm Set Mode to display %LEL or %VOL. When %LEL Alarm Value is changed, %LEL is displayed at Calibration Mode. In the event that %VOL Alarm Value is changed, %VOL is indicated at Calibration Mode. If you don't want the display by %VOL, move to the next step without changing the value at %VOL Alarm Value Change Mode.

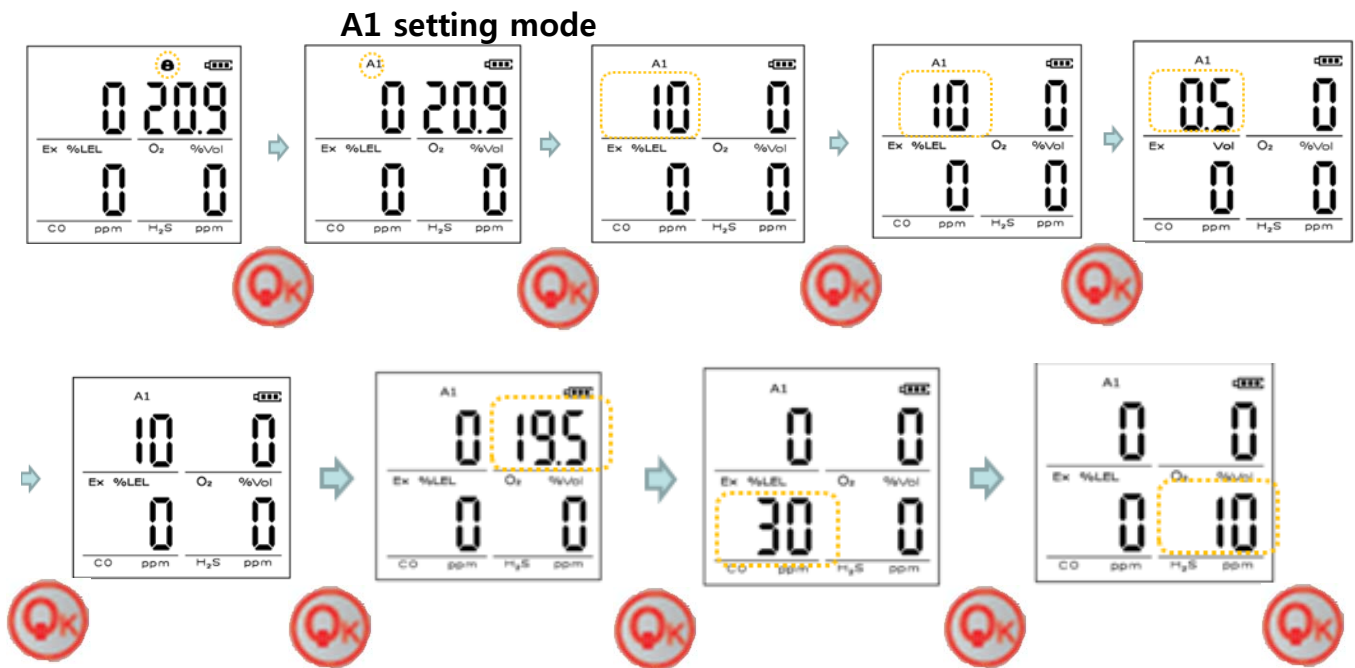

A1 setting mode



At Alarm Value Set Mode, Arrow key represents the increase (change) of 'Number' in lieu of Move. In other words, the number increases by pressing Arrow key, and it moves to the next number with blinks by pressing Power key. Program returns to the initial A1 Set Mode, after changing A1 Alarm Values in sequence of the gases. As mentioned on page 12, the program converts to A2 Alarm Set Mode by pressing Arrow key at A1 Set Mode, and it approaches again to %LEL Alarm Value Set Mode by pressing Power key. Please refer to Operation Flow Chart for the detailed moving path.

Password Input



Password input screen appears by pressing Power key for 5 seconds. Number changes from far left to the right side. It moves upward by each 1 step and blinks by pressing Arrow key, and the blinking 2nd number moves the position by pressing Power key. If you press Arrow key, the number moves upward, and the 3rd number blinks and moves the position by pressing Power key. After completing the change of the last number and enter the Power key, Lock icon blinks with 0.5 second alarm sound if the password is correct. As previously explained, the program moves to Calibration Mode by pressing Move key, and moves to Alarm Set Mode by Power key. If the password is incorrect, it returns to Gas Measure Mode altering the alarm sound.

Changing Password

Caution: The initial password is set as 000. It is impossible to enter Calibration or Alarm Set Mode, if the operator can't remember the new password after changing it. Please be sure not to forget the password.

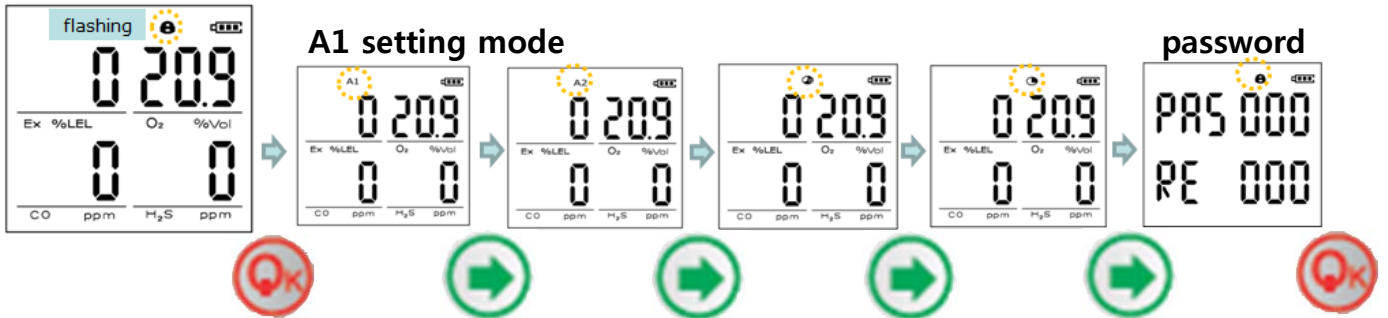

When password icon blinks by moving as the above drawings, press Power key. Then the existing password is displayed blinking from the first digit. If the new password is entered, the existing password is deleted and the new password appears. When the same password is put repeatedly at RE, the password will be changed and the program will return Password Change Mode where Lock icon is blinking. If further change of password is not required, return to Gas Measure Mode by using Arrow key.

Applicable Battery

Caution: It is absolutely prohibited to replace battery at potential explosion areas or dangerous regions. And the charger should be always used at the safe place, since it is not an explosion-proof product.

Specification of the applicable rechargeable battery and disposable battery is as below:

- Disposable Alkaline Battery: Energizer No. E91, Energizer No.EN91
- Rechargeable Ni-H Battery: GP BATTERY GP210AAHCB

It is not permitted to use other batteries for the instrument at dangerous regions.



When the unit is connected to battery charger, power source should be turned off without fail before charging. The state of charging is indicated on LED display of the charger. Red lamp indicates the state of charging, and Green lamp shows the state of the completion of charging. Charging time of rechargeable battery is 5 hours, and it can be used for 12 hours at the state of general measuring.

Warning: Followings may cause the danger of explosion; to use the old battery and the new one together, to use different manufacturer's battery; or to use the batteries of different specification. In order to avoid an accident, please use only the applicable batteries as specified above

Warning: Explosion can occur, when a battery is thrown into fire or disassembled with force. Disposal of the used battery should be performed according to the guide of the pertinent country or the work site.

External Pump (Optional)



 key has the function of On/Off, and the state of operation or trouble of the instrument can be recognized by LED lamp.

When the leakage measurement or the measurement of concentration by inhalation of gas is required, it is available to measure gas concentration and leakage at the pertinent place by connecting the pump to the instrument. Prior to use, make sure that the instrument is tightly attached to the probe cover which is connected to the sensor.

Please note that External Pump is the optional product that can be provided by the separate order.

Battery & Sensor replacement

When you replace the Battery and sensors of SP12C7, you need some instrument and components as below.

- Instrument : + driver, wrench(hexagon)
- Battery : Energizer No.E91, EN91 or GP rechargeable Battery GP210AAHCB
- Sensors for replacement
- Filters for replacement

Warning : - It is absolutely prohibited to replace battery at potential explosion areas or dangerous regions.

- Replacement of components can be damage to intrinsic safety function.
- The sensors published by SENKO should be used for replacement. Unsuitable function could be shown if another sensors use for replacement..
- Disassembly should be necessary only for sensors & battery replacement. After the sensor replacement, the span gas calibration should be done.

Disassembly

- Turn off the power.
- Replace the sensor and battery , please refer to below drawing.
- After replacement, check the sensor fail and battery working.

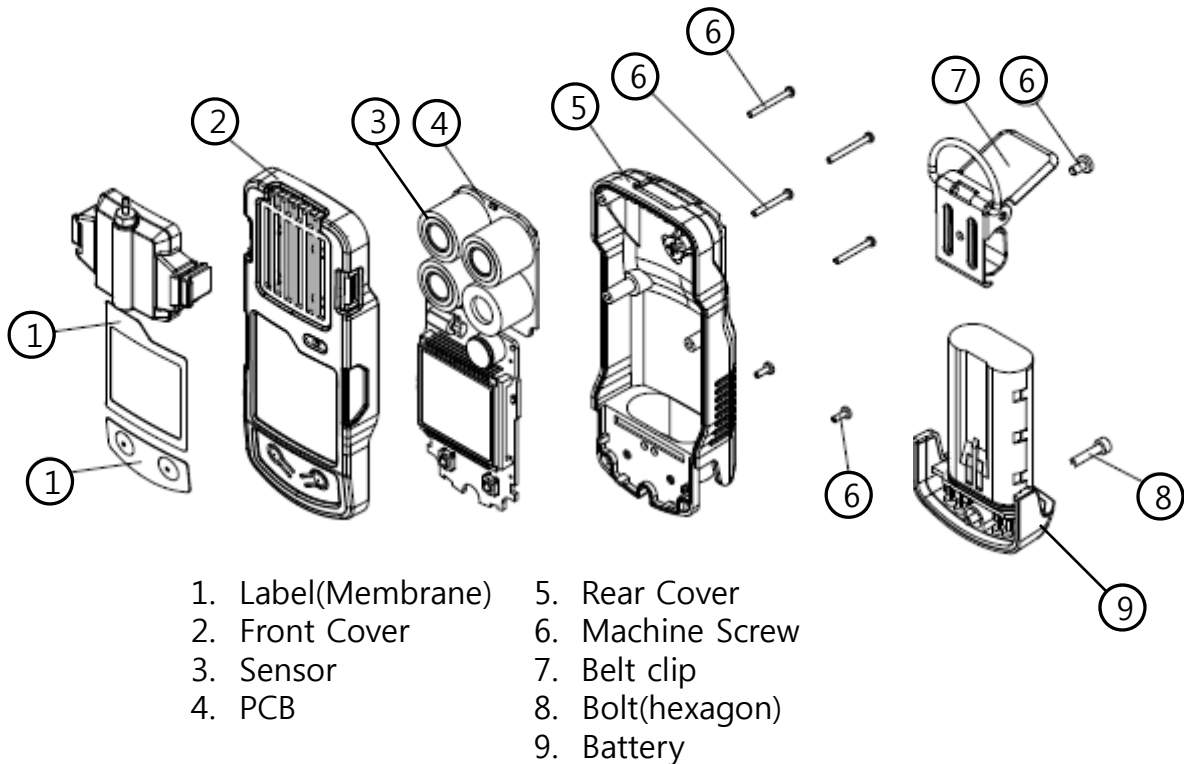

Battery & Sensor replacement

When you replace the Battery and sensors of SP12C7, you need some instrument and components as below.

- Instrument : + driver, wrench(hexagon)
- Battery : Energizer No.E91, EN91 or GP rechargeable Battery GP210AAHCB
- Sensors for replacement
- Filters for replacement

Warning : - It is absolutely prohibited to replace battery at potential explosion areas or dangerous regions.

- Replacement of components can be damage to intrinsic safety function.
- The sensors published by SENKO should be used for replacement. Unsuitable function could be shown if another sensors use for replacement..
- Disassembly should be necessary only for sensors & battery replacement. After the sensor replacement, the span gas calibration should be done.

Disassembly

- Turn off the power.
- Replace the sensor and battery , please refer to below drawing.
- After replacement, check the sensor fail and battery working.

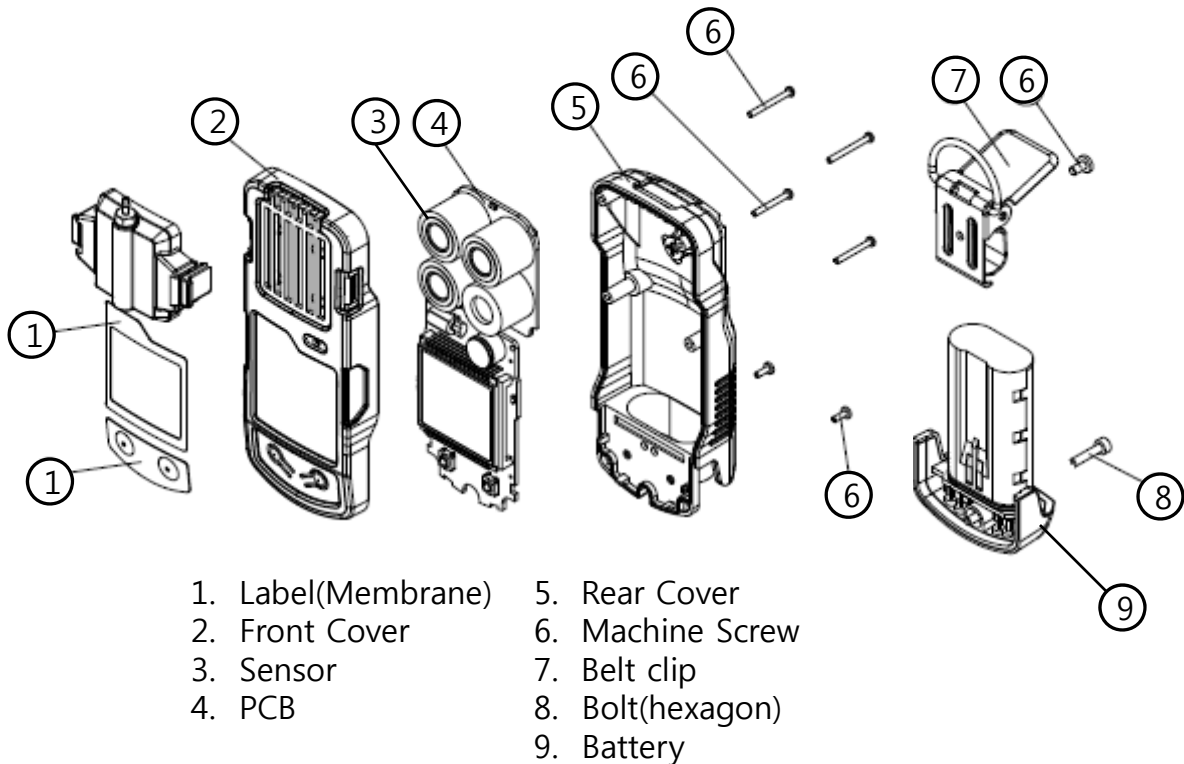

Notice for User

Please use the instrument in the range of the applicable temperature, humidity and pressure that are appropriate for the specification of the product. Using the instrument beyond this range may cause malfunction or glitch of the instrument. .

Gas concentration measurement value by the sensor or the instrument can vary according to the environment at site (temperature, pressure and humidity). Therefore the calibration of the instrument should be performed at the same or similar environment as that of the instrument use (temperature, pressure and humidity),

If temperature changes sharply during use of the instrument (for instance, using the instrument at places of far different temperatures between indoor and outdoor), the value of the measured gas concentration can be changed suddenly. Please use it after the gas concentration value is stabilized. .

Severe vibration or shock to the instrument may cause the sudden change of value of the measured gas concentration. Please use it after the value of gas concentration is stabilized. Excessive shock to the unit can lead to trouble of the sensor or the instrument.